



# STAINLESS STEEL HINGED DOOR STYLE ENCLOSED BASE WORK TABLES



Flat Top



1 1/2" Backsplash



5" Backsplash



FEATURING BOLT-ON  
STAINLESS STEEL LEG

Item #: \_\_\_\_\_ Qty #: \_\_\_\_\_  
 Model #: \_\_\_\_\_  
 Project #: \_\_\_\_\_

## 24" WIDE

Length	FLAT TOP	1 1/2" SPLASH	5" SPLASH	# of Doors	Wt.
36"	HB-SS-243	HF-SS-243	HK-SS-243	2	230 lbs.
48"	HB-SS-244	HF-SS-244	HK-SS-244	2	270 lbs.
60"	HB-SS-245	HF-SS-245	HK-SS-245	2	310 lbs.
72"	HB-SS-246	HF-SS-246	HK-SS-246	4	355 lbs.
84"	HB-SS-247	HF-SS-247	HK-SS-247	4	395 lbs.
96"	HB-SS-248	HF-SS-248	HK-SS-248	4	445 lbs.
108"	HB-SS-249	HF-SS-249	HK-SS-249	4	495 lbs.
120"	HB-SS-2410	HF-SS-2410	HK-SS-2410	4	535 lbs.
144"	HB-SS-2412	HF-SS-2412	HK-SS-2412	6	615 lbs.

## 30" WIDE

Length	FLAT TOP	1 1/2" SPLASH	5" SPLASH	# of Doors	Wt.
36"	HB-SS-303	HF-SS-303	HK-SS-303	2	260 lbs.
48"	HB-SS-304	HF-SS-304	HK-SS-304	2	295 lbs.
60"	HB-SS-305	HF-SS-305	HK-SS-305	2	335 lbs.
72"	HB-SS-306	HF-SS-306	HK-SS-306	4	375 lbs.
84"	HB-SS-307	HF-SS-307	HK-SS-307	4	415 lbs.
96"	HB-SS-308	HF-SS-308	HK-SS-308	4	460 lbs.
108"	HB-SS-309	HF-SS-309	HK-SS-309	4	505 lbs.
120"	HB-SS-3010	HF-SS-3010	HK-SS-3010	4	550 lbs.
144"	HB-SS-3012	HF-SS-3012	HK-SS-3012	6	635 lbs.

## 36" WIDE

Length	FLAT TOP	1 1/2" SPLASH	5" SPLASH	# of Doors	Wt.
36"	HB-SS-363	HF-SS-363	HK-SS-363	2	290 lbs.
48"	HB-SS-364	HF-SS-364	HK-SS-364	2	330 lbs.
60"	HB-SS-365	HF-SS-365	HK-SS-365	2	370 lbs.
72"	HB-SS-366	HF-SS-366	HK-SS-366	4	415 lbs.
84"	HB-SS-367	HF-SS-367	HK-SS-367	4	455 lbs.
96"	HB-SS-368	HF-SS-368	HK-SS-368	4	500 lbs.
108"	HB-SS-369	HF-SS-369	HK-SS-369	4	555 lbs.
120"	HB-SS-3610	HF-SS-3610	HK-SS-3610	4	615 lbs.
144"	HB-SS-3612	HF-SS-3612	HK-SS-3612	6	685 lbs.

Mid Shelves Are Available.

To Add a Fixed Mid Shelf, Add "M" After each Model Number.  
 Upgrade to Adjustable Mid Shelf. Add TA-116.

### FEATURES:

**FLAT TOP** is furnished with a 1 5/8" sanitary rolled rim on the front and 1 5/8" square bend edges on the 2 sides and rear.

**1 1/2" SPLASH** is furnished with a 1 5/8" sanitary rolled rim on the front side and 1 5/8" square bend edges on the 2 sides and a 1 1/2" splash of single metal thickness on the rear side.

**5" SPLASH** is furnished with a 1 5/8" sanitary rolled rim on the front side and 1 5/8" square bend edges on the 2 sides and a 5" splash with a 1" return on the rear side.

**HINGED DOORS** are constructed as double panel doors with recessed inner panels for extra rigidity.

Rear flush panel along the rear of the base unit.

### CONSTRUCTION:

All TIG welded. Exposed areas finished to match adjacent surfaces.

Entire Top is mechanically polished to a satin finish and is sound deadened.

Hat section secured to Top reinforces and maintains level working surface.

UNI-BODY DESIGN sides, back and fixed mid shelf (sold separately) are welded to form a single rigid structure.

Legs bolt on to table base.

### MATERIAL:

TOP is 14 gauge stainless steel type "304" series with galvanized understructure.

BODY is 18 gauge stainless steel type "430" series.

LEGS are stainless steel and include 1 1/2" adjustable hex foot.



Customer Service Available To Assist You 1-800-645-3166 8:30 am - 8:00 pm E.S.T.

For Orders & Customer Service:

Email: customer@advancetabco.com or Fax: 631-242-6900

For Smart Fabrication™ Quotes:

Email: smartfab@advancetabco.com or Fax: 631-586-2933

# DETAILS and SPECIFICATIONS

TOL ± .500"

Units 7' and larger are furnished with 6 legs.

ALL DIMENSIONS ARE TYPICAL

## HB-Series Flat Top

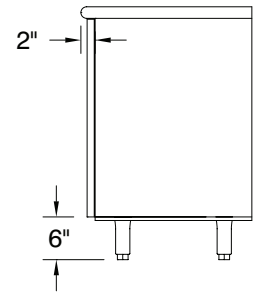
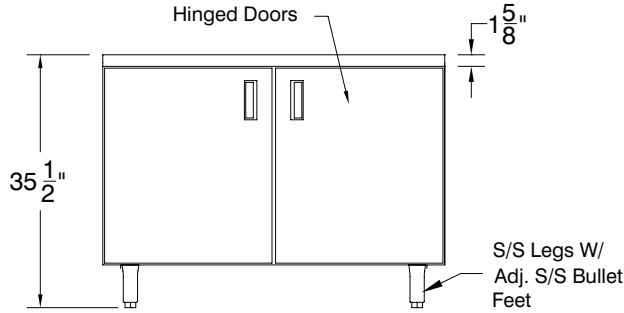
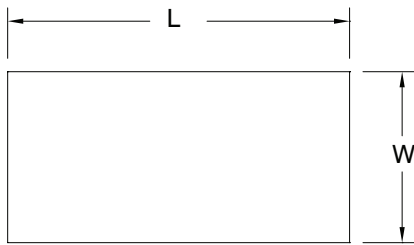

## HF-Series 1 1/2" Rear Splash

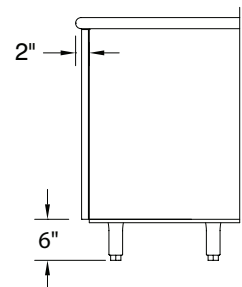
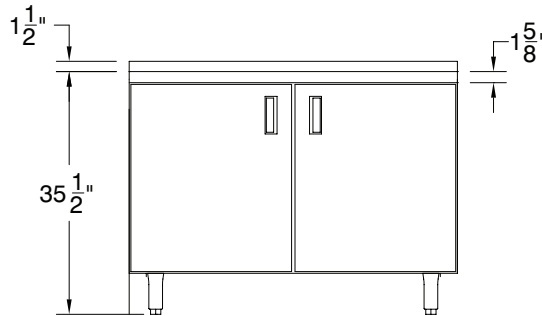
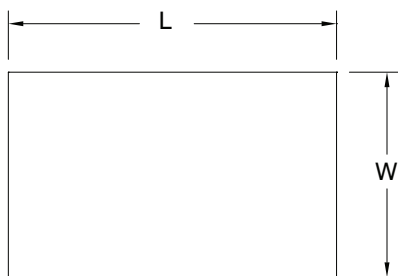

## HK-Series 5" Rear Splash

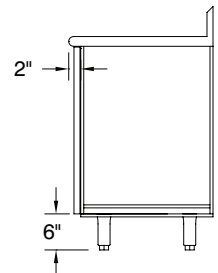
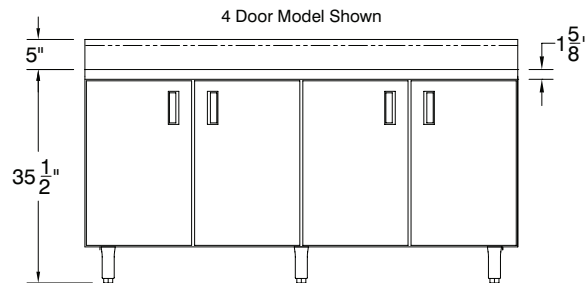
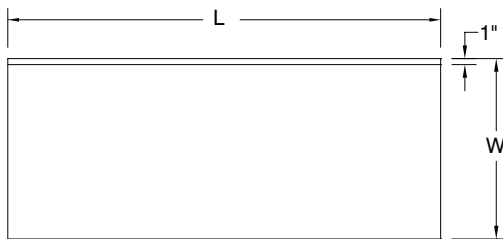

### OPTIONAL MID SHELF DETAILS

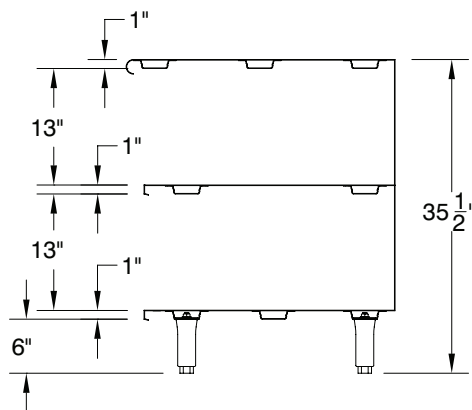

### OPTIONAL ENCLOSED BASE ACCESSORIES

- TA-20L ..... Replacement Bolt-on Leg
- TA-19L ..... Replacement Bolt-on Leg  
With Flanged Bullet Foot
- TA-255P ..... 5" Heavy Duty Polyurethane Casters  
(set of 4 - 2 w/ Brakes)
- TA-255AP.... 5" Heavy Duty Polyurethane Casters  
(set of 6 - 2 w/ Brakes)
- TA-46 ..... Door Locks
- TA-54 ..... Removable Kick Plate

### TA-116 ADJUSTABLE ENCLOSED BASE CABINET MID SHELF (Sold Separately)

*Shelves Over 36" In Length Require Multiple Sections With Center Partition.*

