

PRODUCT:

QUANTITY:

Models GGT-18i GGT-24i GGT-36i GGT-48i
ITEM:

Designed Smart

Increased Performance

- Fast start-up to prime cooking temperatures
- Provides fast recovery and the ability to handle a variety of foods
- Openings in the front allow the pilot light to be easily lit and adjusted without removing the front panel

Safety Features

- Bull-nose front extension protects employees from burns

Saves Time and Clean-up Labor Cost

- Maintenance is easier with bottom-mount grease collection pan
- Field convertible and adjustable gas regulator



Model GGT-24i Gas Thermostatic Griddle

APW Wyott Design Features

- 1" (2cm) flat polished "hot rolled" steel griddle plate
- 3" (7.6) stainless steel backsplash; sloped side splashers
- Front access panels for easy adjustment
- Extended bull-nose front
- Heavy-duty 4" (10.2cm) heat-resistant, adjustable legs
- Field convertible gas regulator
- Viewable standing pilot. Safety pilot available
- Snap action thermostats.
- Pilot can be lit without removing front panel
- Gas connections use 3/4" NPT pipe
- 4" x 1" (10.2 cm x 2.5 cm) grease chute drains into grease drawer
- Stainless steel grease collector pan

Options & Accessories

- High altitude versions are available (contact factory)
- Safety pilot

Reliability backed by APW Wyott's Warranty

All APW Wyott Heavy Duty Cookline Equipment is backed by our 2-year parts and labor warranty.

•Certified by the following agencies:



*Warranty does not include rock grates, cooking grates, burners shields or fireboxes.

See reverse side for product specifications.

PRODUCT:

QUANTITY:

Models GGT-18i GGT-24i GGT-36i GGT-48i
ITEM:

GGT-24i

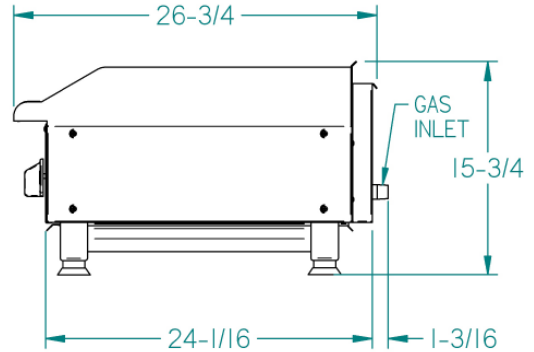
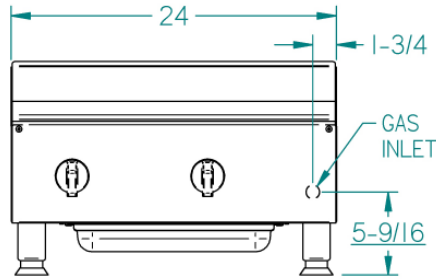

PRODUCT SPECIFICATION

Construction:

Stainless steel top skirt, grease trough, grease collector drawer, and front panel. Aluminized steel sides and back panel. 4" adjustable legs. Welded construction. Field convertible and adjustable gas regulator.

Gas Specifications:

- GGT-18i: 1 "S" burner, total 37,500 BTU/6.5 kW. One manual control. (Propane is 33,750 BTU/6.5 kW.)
- GGT-24i: 2 "U" burners, total 25,000 BTU/7.4 kW. each. Total 50,000 BTU/14.8 kW. input. Two manual high-low controls. (Propane is 45,000 BTU/13.2 kW.)
- GGT-36i: 3 "U" burners, 25,000 BTU/7.4 kW. each. Total 75,000 BTU/22.2 kW. input. Two manual high-low controls. (Propane is 67,500 BTU/19.8 kW.)
- GGT-48i: 4 "U" burners, 25,000 BTU/7.4 kW. each. Total 100,000 BTU/29.6 kW. input. Two manual high-low controls. (Propane is 90,000 BTU/26.4 kW.)

Cooking Surface:

- GGT-18i: 19 1/2" D x 17 3/4"W
- GGT-24i: 19 1/2" D x 23 3/4"W
- GGT-36i: 19 1/2" D x 35 3/4"W
- GGT-48i: 19 1/2" D x 47 3/4"W

Overall Dimensions:

- GGT-18i: 15 3/4" H x 18" W x 26 3/4"D
- GGT-24i: 15 3/4" H x 24" W x 26 3/4"D
- GGT-36i: 15 3/4" H x 36" W x 26 3/4"D
- GGT-48i: 15 3/4" H x 48" W x 26 3/4"D

***NOTE: Regulator and pipe add 4 1/4" to the rear of the unit.**

Shipping Information:

- GGT-18i: 185 lbs.
- GGT-24i: 256 lbs
- GGT-36i: 356 lbs
- GGT-48i: 416 lbs

Freight Class: 70

FOB: Allen, TX 75013

*APW Wyott reserves the right to modify specifications or discontinue models without incurring obligation.